

IRS2183/IRS21834(S)PbF

HALF-BRIDGE DRIVER

Features

- Floating channel designed for bootstrap operation
- Fully operational to +600 V
- Tolerant to negative transient voltage, dV/dt immune
- Gate drive supply range from 10 V to 20 V
- Undervoltage lockout for both channels
- 3.3 V and 5 V input logic compatible
- Matched propagation delay for both channels
- Logic and power ground +/- 5 V offset
- Lower di/dt gate driver for better noise immunity
- Output source/sink current capability 1.4 A/1.8 A

Description

The IRS2183/IRS21834 are high voltage, high speed power MOSFET and IGBT drivers with dependent high and low side referenced output channels. Proprietary HVIC and latch immune CMOS technologies enable ruggedized monolithic construction. The logic input is compatible with standard CMOS or LSTTL output, down to 3.3 V logic. The output drivers feature a high pulse current buffer stage designed for minimum

driver cross-conduction. The floating channel can be used to drive an N-channel power MOSFET or IGBT in the high side configuration which operates up to 600 V.

Packages

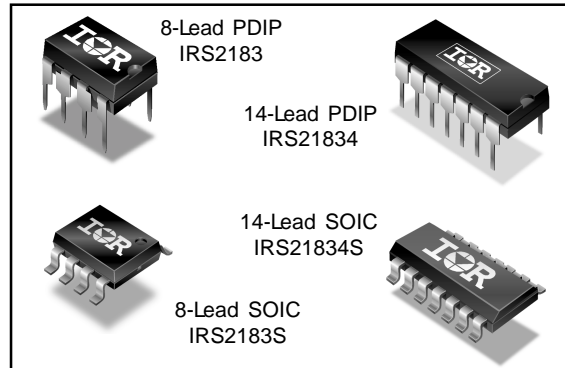

Feature Comparison

Part	Input logic	Cross-conduction prevention logic	Deadtime (ns)	Ground Pins	Ton/Toff (ns)
2181	HIN/LIN	no	none	COM	180/220
21814				V _{SS} /COM	
2183	HIN/LIN	yes	Internal 5000 Program 400-5000	COM	180/220
21834				V _{SS} /COM	
2184	IN/SD	yes	Internal 5000 Program 400-5000	COM	680/270
21844				V _{SS} /COM	

Typical Connection

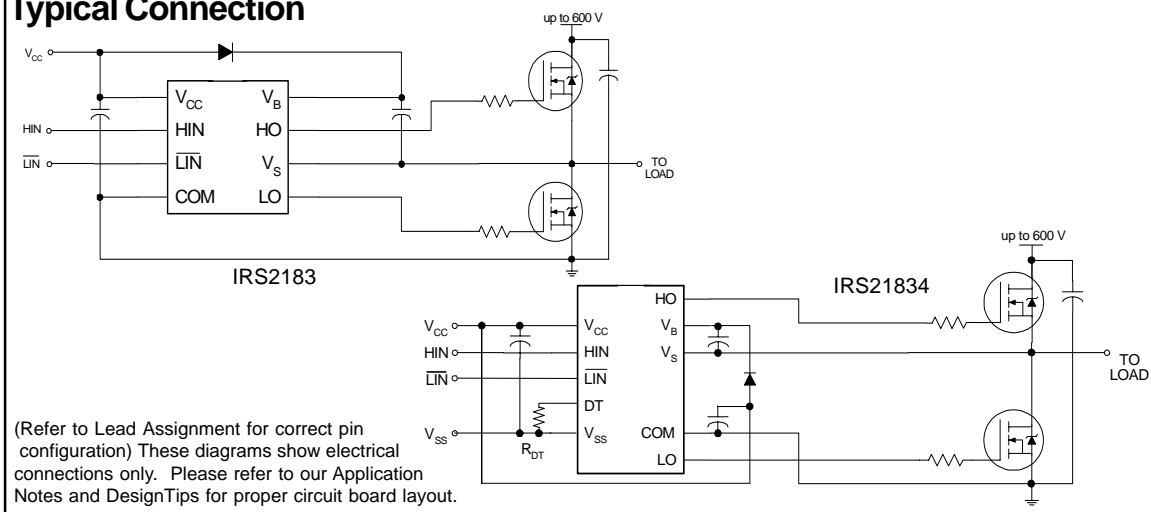

Absolute Maximum Ratings

Absolute maximum ratings indicate sustained limits beyond which damage to the device may occur. All voltage parameters are absolute voltages referenced to COM. The thermal resistance and power dissipation ratings are measured under board mounted and still air conditions.

Symbol	Definition	Min.	Max.	Units	
V _B	High side floating absolute voltage	-0.3	620 (Note 1)	V	
V _S	High side floating supply offset voltage	V _B - 20	V _B + 0.3		
V _{HO}	High side floating output voltage	V _S - 0.3	V _B + 0.3		
V _{CC}	Low side and logic fixed supply voltage	-0.3	20 (Note 1)		
V _{LO}	Low side output voltage	-0.3	V _{CC} + 0.3		
DT	Programmable deadtime pin voltage (IR21834 only)	V _{SS} - 0.3	V _{CC} + 0.3		
V _{IN}	Logic input voltage (HIN & $\overline{\text{LIN}}$)	V _{SS} - 0.3	V _{CC} + 0.3		
V _{SS}	Logic ground (IR21834 only)	V _{CC} - 20	V _{CC} + 0.3		
dV _S /dt	Allowable offset supply voltage transient	—	50	V/ns	
P _D	Package power dissipation @ T _A ≤ +25 °C	(8-lead PDIP)	—	1.0	W
		(8-lead SOIC)	—	0.625	
		(14-lead PDIP)	—	1.6	
		(14-lead SOIC)	—	1.0	
R _{thJA}	Thermal resistance, junction to ambient	(8-lead PDIP)	—	125	°C/W
		(8-lead SOIC)	—	200	
		(14-lead PDIP)	—	75	
		(14-lead SOIC)	—	120	
T _J	Junction temperature	—	150	°C	
T _S	Storage temperature	-50	150		
T _L	Lead temperature (soldering, 10 seconds)	—	300		

Note 1: All supplies are fully tested at 25 V and an internal 20 V clamp exists for each supply.

Recommended Operating Conditions

The input/output logic timing diagram is shown in Fig. 1. For proper operation the device should be used within the recommended conditions. The V_S and V_{SS} offset rating are tested with all supplies biased at 15 V differential.

Symbol	Definition	Min.	Max.	Units
V _B	High side floating supply absolute voltage	V _S + 10	V _S + 20	V
V _S	High side floating supply offset voltage	Note 2	600	
V _{HO}	High side floating output voltage	V _S	V _B	
V _{CC}	Low side and logic fixed supply voltage	10	20	
V _{LO}	Low side output voltage	0	V _{CC}	
V _{IN}	Logic input voltage (HIN & $\overline{\text{LIN}}$)	V _{SS}	V _{CC}	
DT	Programmable deadtime pin voltage (IR21834 only)	V _{SS}	V _{CC}	
V _{SS}	Logic ground (IR21834 only)	-5	5	
T _A	Ambient temperature	-40	125	°C

Note 2: Logic operational for V_S of -5 V to +600 V. Logic state held for V_S of -5 V to -V_{BS}. (Please refer to the Design Tip DT97-3 for more details).

Dynamic Electrical Characteristics

V_{BIAS} (V_{CC} , V_{BS}) = 15 V, V_{SS} = COM, C_L = 1000 pF, T_A = 25 °C, DT = V_{SS} unless otherwise specified.

Symbol	Definition	Min.	Typ.	Max.	Units	Test Conditions
t_{on}	Turn-on propagation delay	—	180	270	ns	$V_S = 0V$
t_{off}	Turn-off propagation delay	—	220	330		$V_S = 0V$ or 600V
MT	Delay matching $ t_{on} - t_{off} $	—	0	35		
t_r	Turn-on rise time	—	40	60		$V_S = 0V$
t_f	Turn-off fall time	—	20	35		
DT	Deadtime: LO turn-off to HO turn-on (DT _{LO-HO}) & HO turn-off to LO turn-on (DT _{HO-LO})	280	400	520	μs	$R_{DT} = 0 \Omega$
		4	5	6		$R_{DT} = 200 k\Omega$ (IR21834)
MDT	Deadtime matching = $ DT_{LO-HO} - DT_{HO-LO} $	—	0	50	ns	$R_{DT} = 0 \Omega$
		—	0	600		$R_{DT} = 200 k\Omega$ (IR21834)

Static Electrical Characteristics

V_{BIAS} (V_{CC} , V_{BS}) = 15 V, V_{SS} = COM, $DT = V_{SS}$ and $T_A = 25$ °C unless otherwise specified. The V_{IL} , V_{IH} , and I_{IN} parameters are referenced to V_{SS}/COM and are applicable to the respective input leads: HIN and LIN. The V_O , I_O , and R_{on} parameters are referenced to COM and are applicable to the respective output leads: HO and LO.

Symbol	Definition	Min.	Typ.	Max.	Units	Test Conditions
V_{IH}	Logic "1" input voltage for HIN & logic "0" for LIN	2.5	—	—	V	$V_{CC} = 10V$ to 20 V
V_{IL}	Logic "0" input voltage for HIN & logic "1" for LIN	—	—	0.8		$I_O = 0A$
V_{OH}	High level output voltage, $V_{BIAS} - V_O$	—	—	1.2		$I_O = 20mA$
V_{OL}	Low level output voltage, V_O	—	—	0.2	μA	$V_B = V_S = 600V$
I_{LK}	Offset supply leakage current	—	—	50		$V_{IN} = 0V$ or 5 V
I_{QBS}	Quiescent V_{BS} supply current	20	60	150	mA	
I_{QCC}	Quiescent V_{CC} supply current	0.4	1.0	1.6		
I_{IN+}	Logic "1" input bias current	—	25	60	μA	$HIN = 5V, \overline{LIN} = 0V$
I_{IN-}	Logic "0" input bias current	—	—	1.0		$HIN = 0V, \overline{LIN} = 5V$
V_{CCUV+} V_{BSUV+}	V_{CC} and V_{BS} supply undervoltage positive going threshold	8.0	8.9	9.8	V	
V_{CCUV-} V_{BSUV-}	V_{CC} and V_{BS} supply undervoltage negative going threshold	7.4	8.2	9.0		
V_{CCUVH} V_{BSUVH}	Hysteresis	0.3	0.7	—		
I_{O+}	Output high short circuit pulsed current	1.4	1.9	—	A	$V_O = 0V,$ $PW \leq 10 \mu s$
I_{O-}	Output low short circuit pulsed current	1.8	2.3	—		$V_O = 15V,$ $PW \leq 10 \mu s$

Functional Block Diagrams



Lead Definitions

Symbol	Description
HIN	Logic input for high side gate driver output (HO), in phase (referenced to COM for IRS2183 and VSS for IRS21834)
$\overline{\text{LIN}}$	Logic input for low side gate driver output (LO), out of phase (referenced to COM for IRS2183 and VSS for IRS21834)
DT	Programmable deadtime lead, referenced to VSS. (IRS21834 only)
VSS	Logic ground (IRS21834 only)
V _B	High side floating supply
HO	High side gate driver output
V _S	High side floating supply return
V _{CC}	Low side and logic fixed supply
LO	Low side gate driver output
COM	Low side return

Lead Assignments

<p>8-Lead PDIP</p>	<p>8-Lead SOIC</p>
IRS2183PbF	IRS2183SPbF
<p>14-Lead PDIP</p>	<p>14-Lead SOIC</p>
IRS21834PbF	IRS21834SPbF

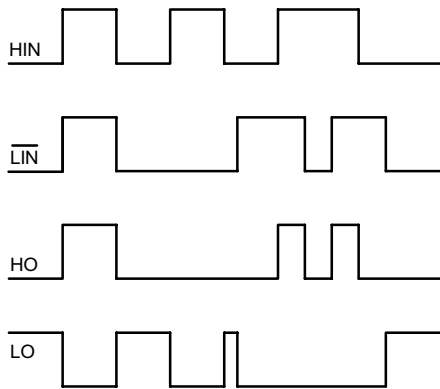

Figure 1. Input/Output Timing Diagram

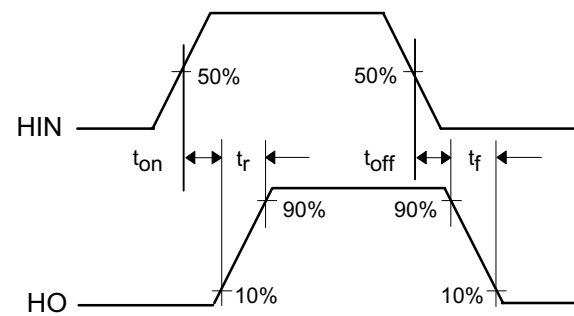
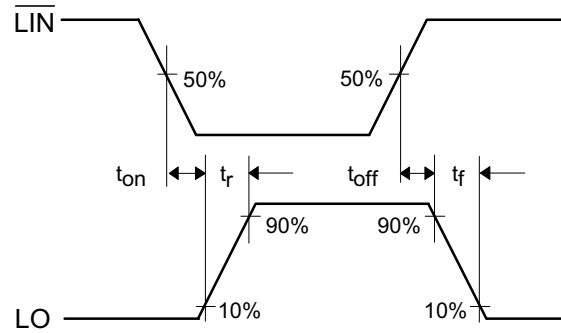

Figure 2. Switching Time Waveform Definitions

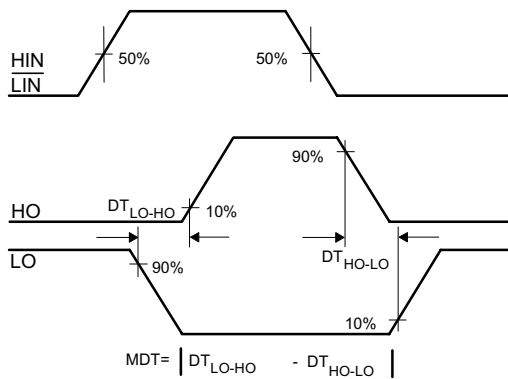

Figure 3. Deadtime Waveform Definitions

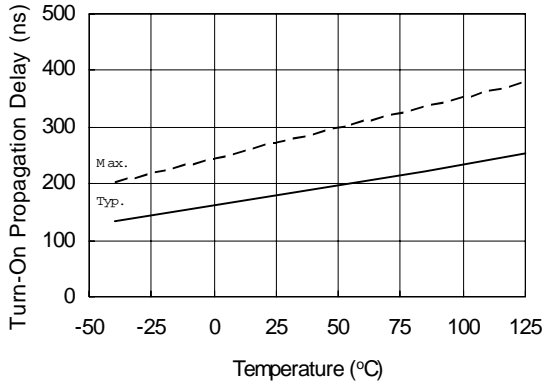

Figure 4A. Turn-On Propagation Delay vs. Temperature

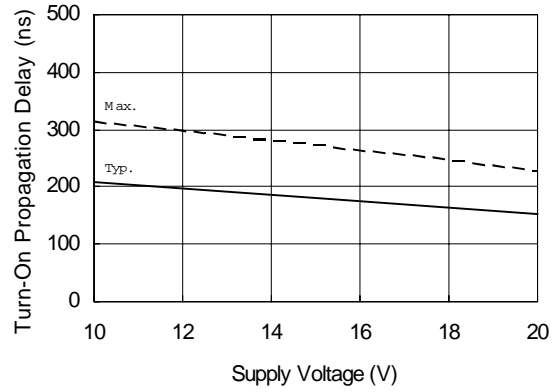

Figure 4B. Turn-On Propagation Delay vs. Supply Voltage

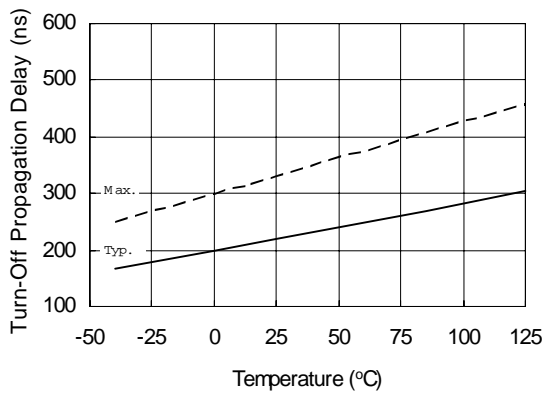

Figure 5A. Turn-Off Propagation Delay vs. Temperature

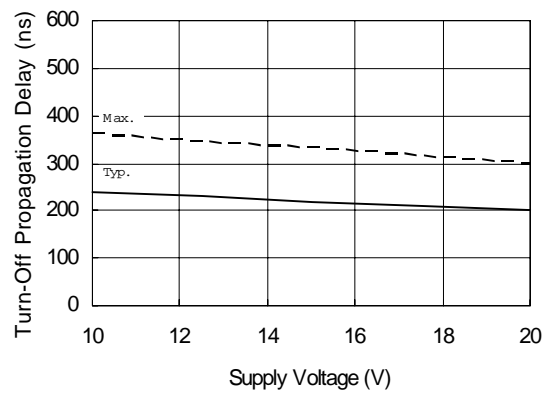

Figure 5B. Turn-Off Propagation Delay vs. Supply Voltage

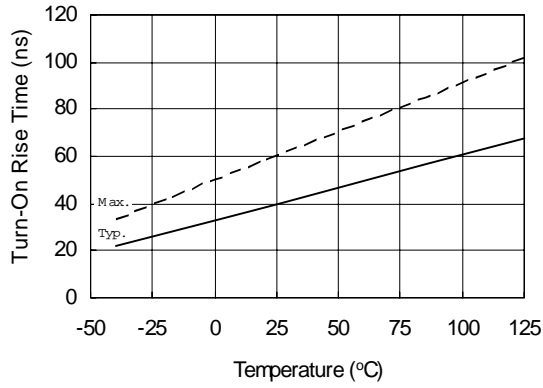

Figure 6A. Turn-On Rise Time vs. Temperature

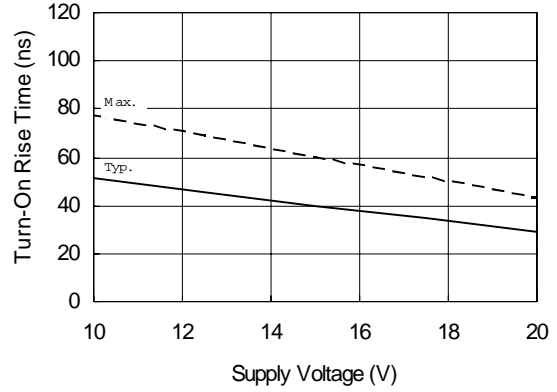

Figure 6B. Turn-On Rise Time vs. Supply Voltage

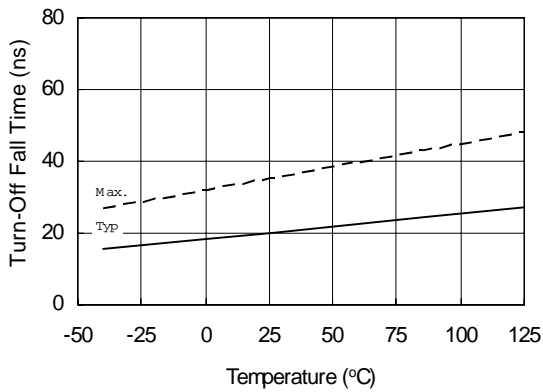

Figure 7A. Turn-Off Fall Time vs. Temperature

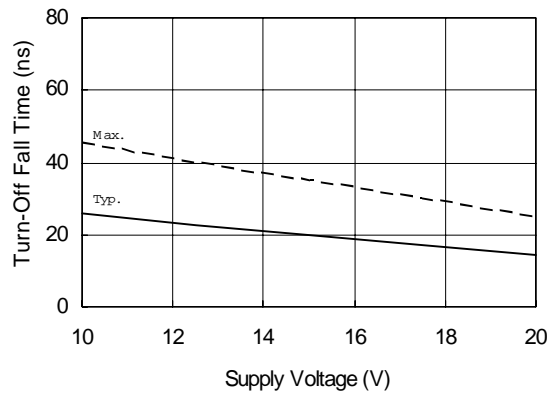

Figure 7B. Turn-Off Fall Time vs. Supply Voltage

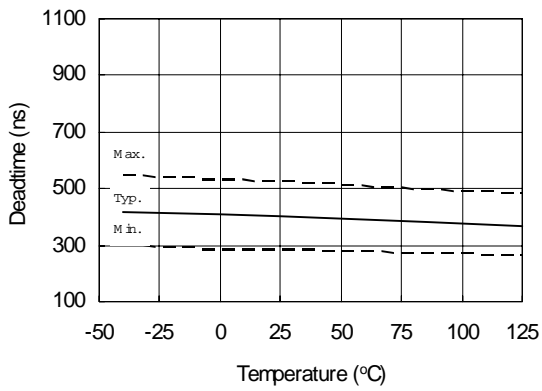

Figure 8A. Deadtime vs. Temperature

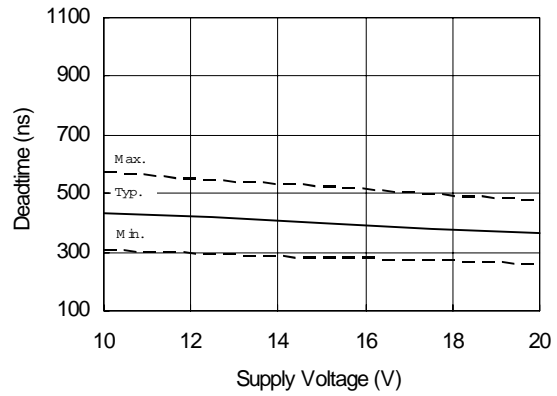

Figure 8B. Deadtime vs. Supply Voltage

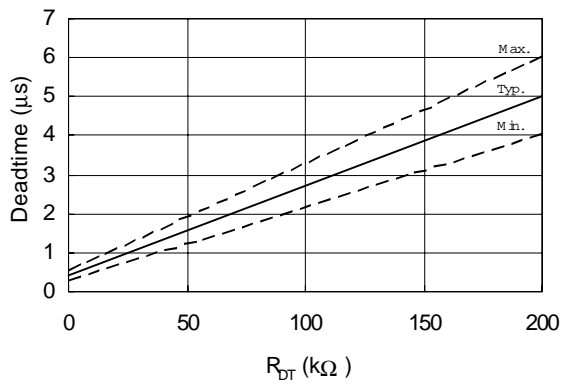

Figure 8C. Deadtime vs. R_{DT}

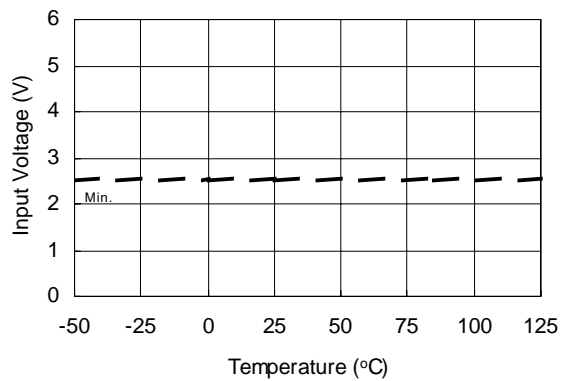

Figure 9A. Logic "1" Input Voltage vs. Temperature

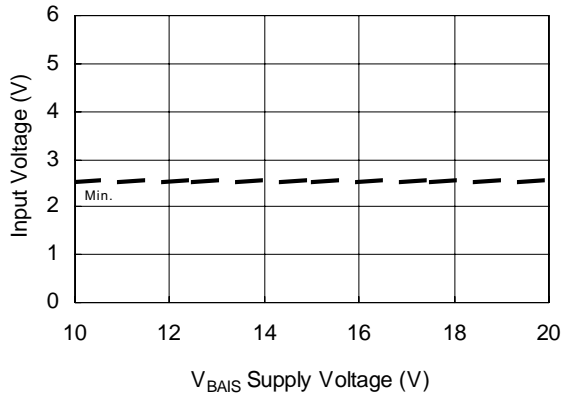

Figure 9B. Logic "1" Input Voltage vs. Supply Voltage

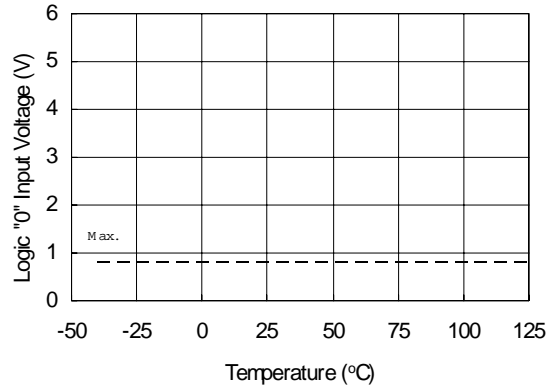

Figure 10A. Logic "0" Input Voltage vs. Temperature

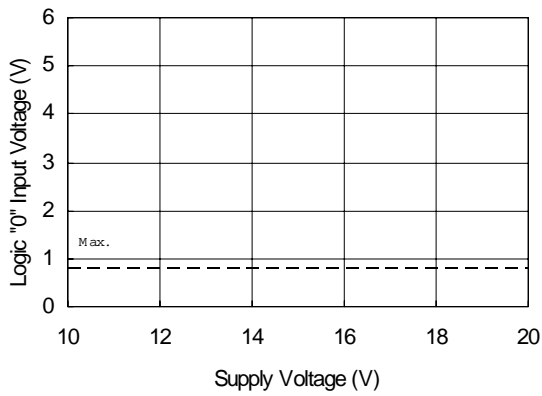

Figure 10B. Logic "0" Input Voltage vs. Supply Voltage

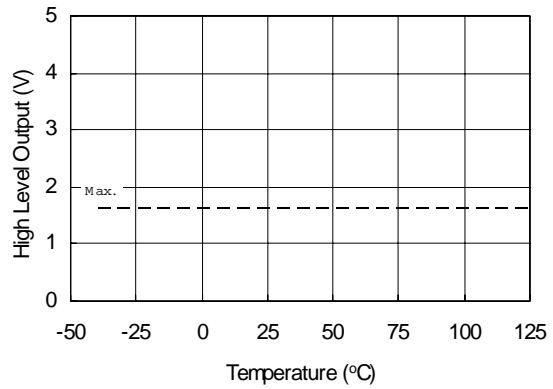

Figure 11A. High Level Output vs. Temperature

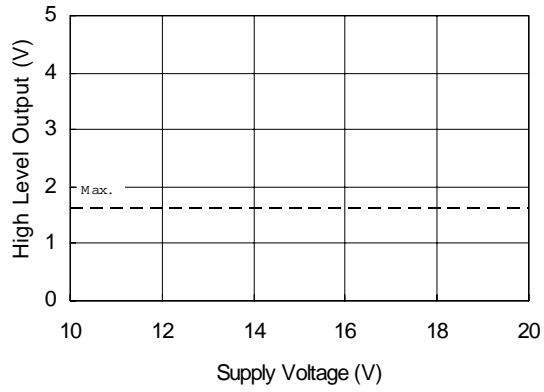

Figure 11B. High Level Output vs. Supply Voltage

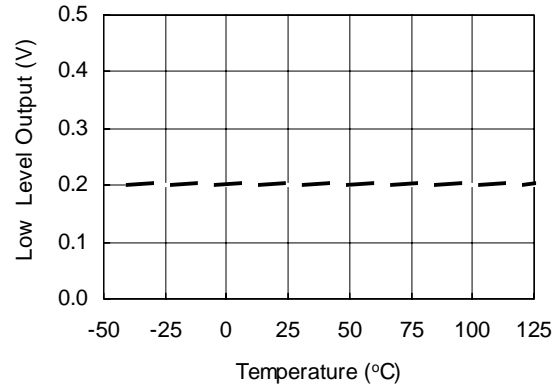

Figure 12A. Low Level Output vs. Temperature

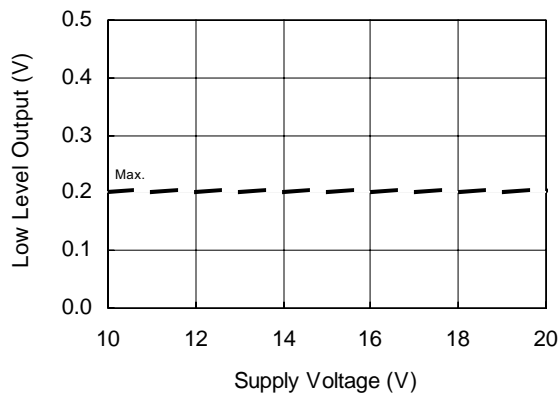

Figure 12B. Low Level Output vs. Supply Voltage

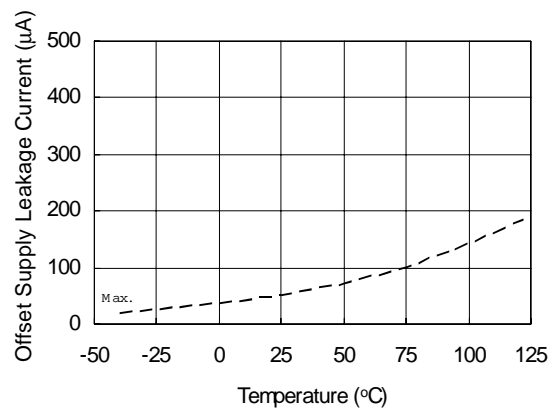

Figure 13A. Offset Supply Leakage Current vs. Temperature

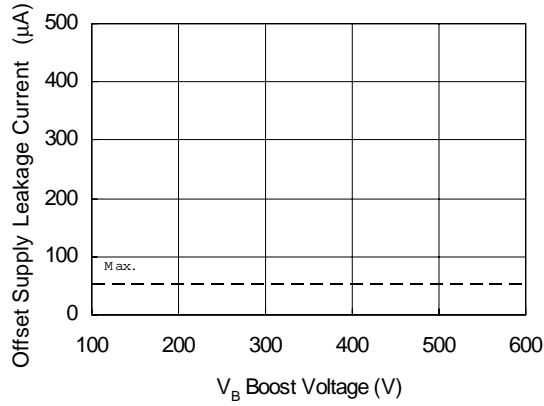

Figure 13B. Offset Supply Leakage Current vs. V_B Boost Voltage

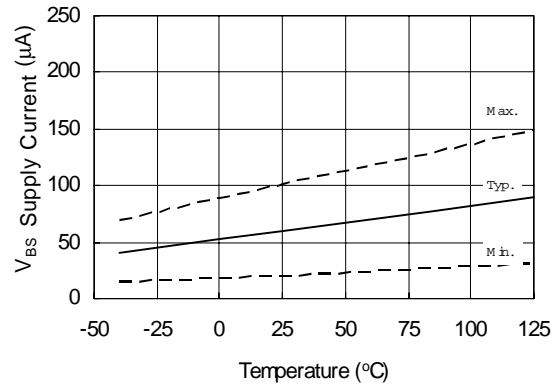

Figure 14A. V_{BS} Supply Current vs. Temperature

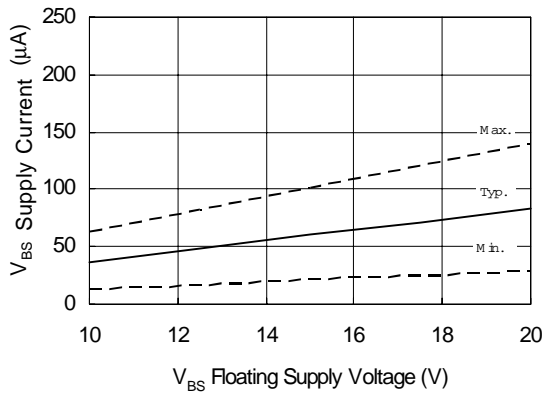

Figure 14B. V_{BS} Supply Current vs. V_{BS} Floating Supply Voltage

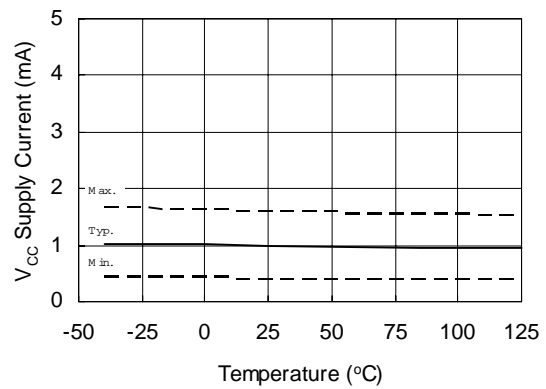

Figure 15A. V_{CC} Supply Current vs. Temperature

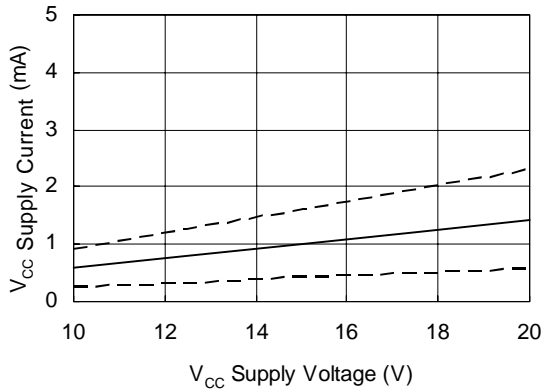

Figure 15B. V_{CC} Supply Current vs. V_{CC} Supply Voltage

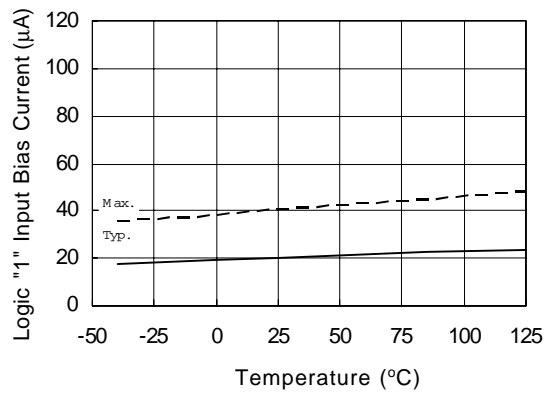

Figure 16A. Logic "1" Input Bias Current vs. Temperature

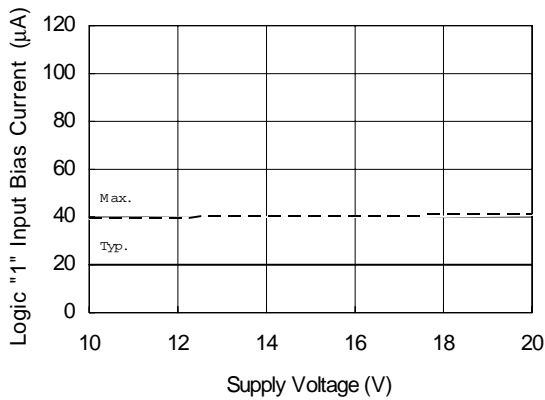

Figure 16B. Logic "1" Input Bias Current vs. Supply Voltage

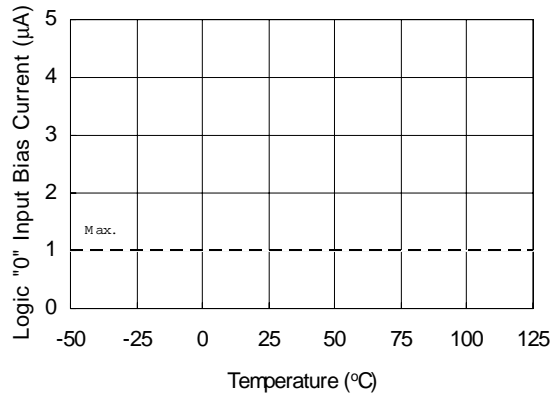

Figure 17A. Logic "0" Input Bias Current vs. Temperature

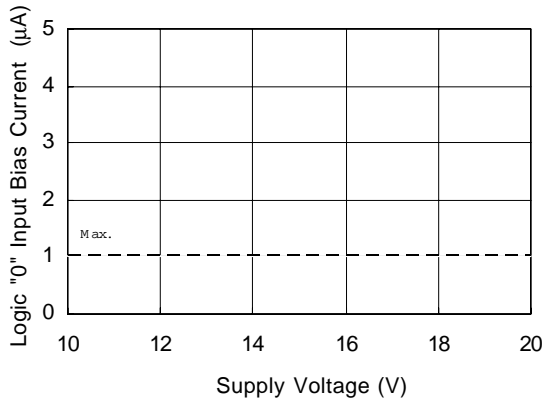

Figure 17B. Logic "0" Input Bias Current vs. Supply Voltage

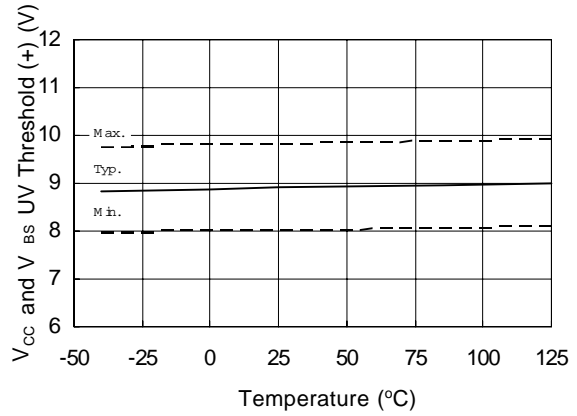

Figure 18. V_{CC} and V_{BS} Undervoltage Threshold (+) vs. Temperature

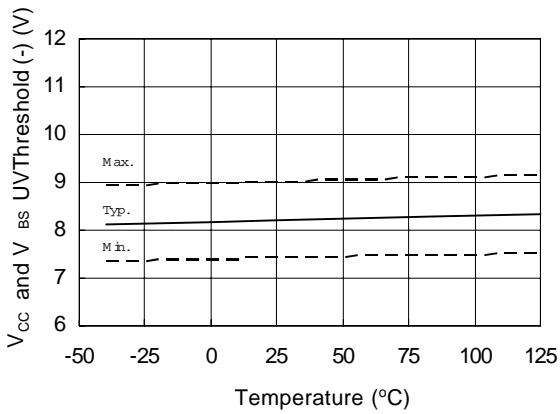

Figure 19. V_{CC} and V_{BS} Undervoltage Threshold (-) vs. Temperature

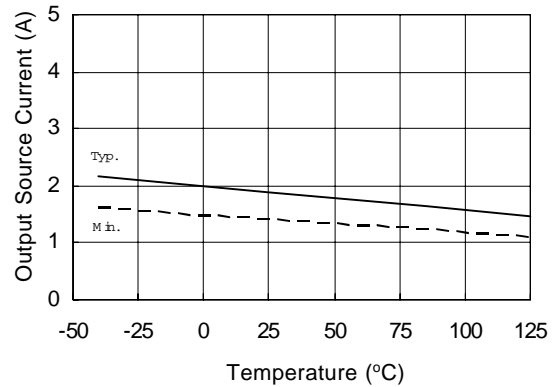

Figure 20A. Output Source Current vs. Temperature

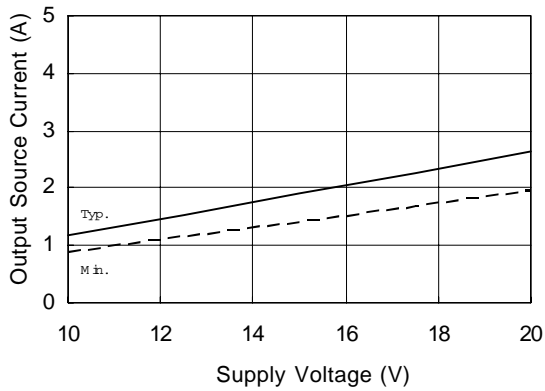

Figure 20B. Output Source Current vs. Supply Voltage

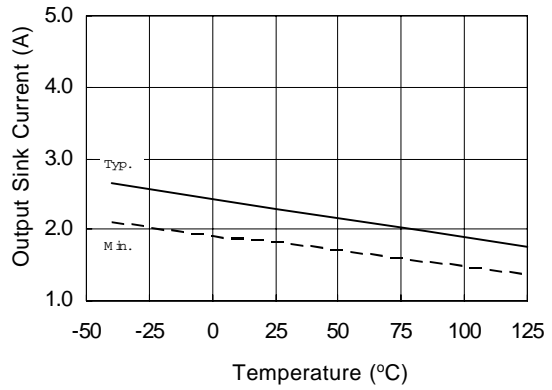

Figure 21A. Output Sink Current vs. Temperature

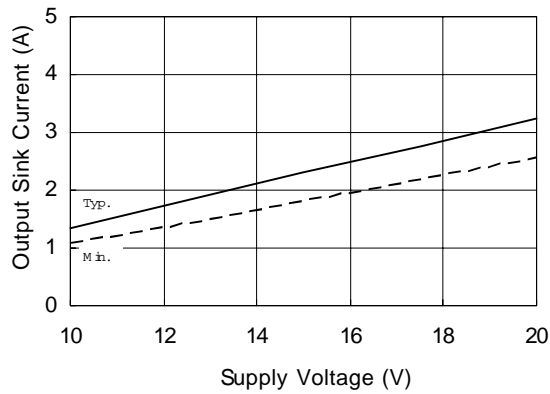
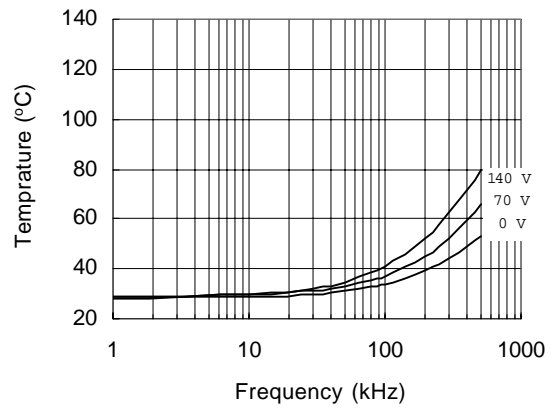
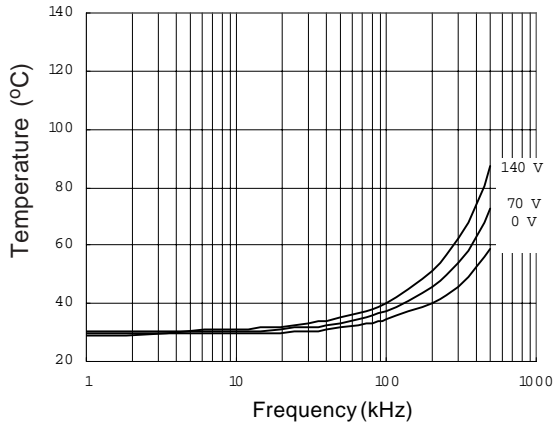

Figure 21B. Output Sink Current vs. Supply Voltage

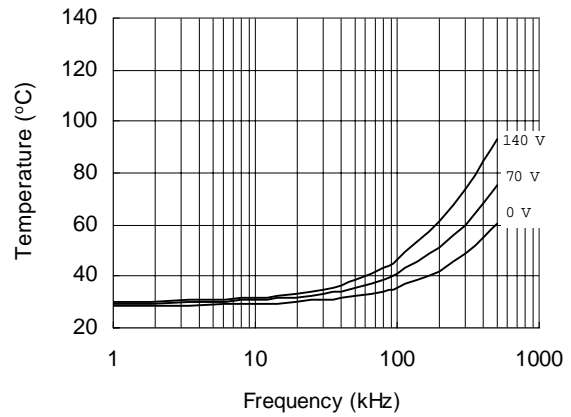

**Figure 22. IR2S183 vs. Frequency (IRFBC20),
 $R_{gate}=33 \Omega$, $V_{CC}=15 V$**

IRS2183/IRS21834(S)PbF



**Figure 23. IRS2183 vs. Frequency (IRFBC30),
 $R_{gate}=22 \Omega$, $V_{CC}=15 V$**



**Figure 24. IRS2183 vs. Frequency (IRFBC40),
 $R_{gate}=15 \Omega$, $V_{CC}=15 V$**

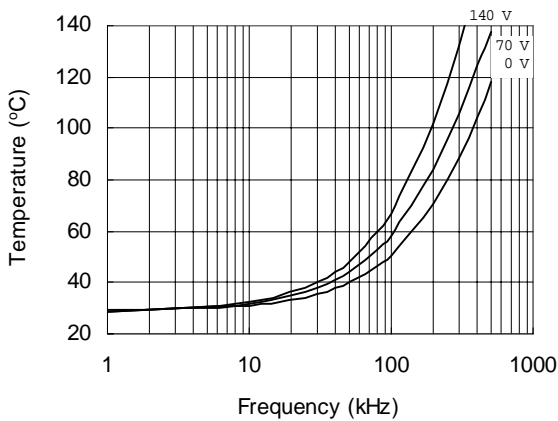

**Figure 25. IRS2183 vs. Frequency (IRFPE50),
 $R_{gate}=10 \Omega$, $V_{CC}=15 V$**

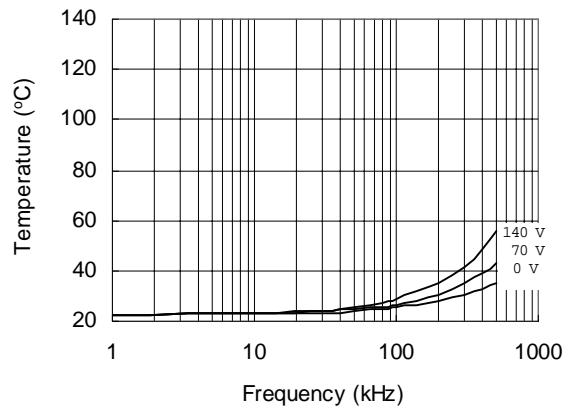

**Figure 26. IRS21834 vs. Frequency (IRFBC20),
 $R_{gate}=33 \Omega$, $V_{CC}=15 V$**

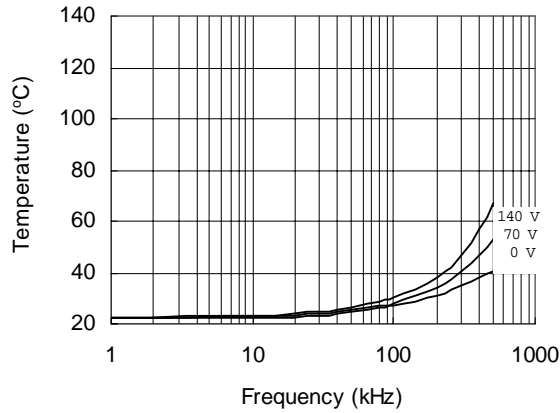

Figure 27. IRS21834 vs. Frequency (IRFBC30),
 $R_{gate}=22 \Omega, V_{CC}=15 V$

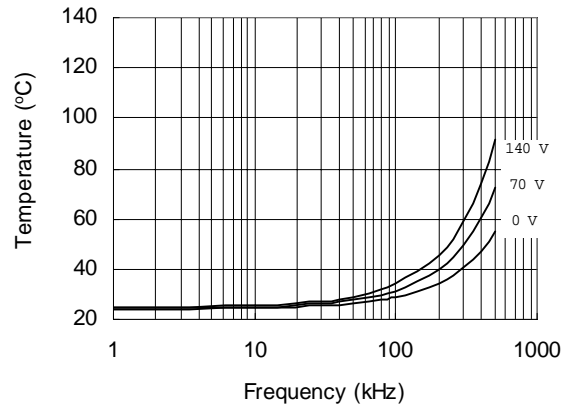

Figure 28. IRS21834 vs. Frequency (IRFBC40),
 $R_{gate}=15 \Omega, V_{CC}=15 V$

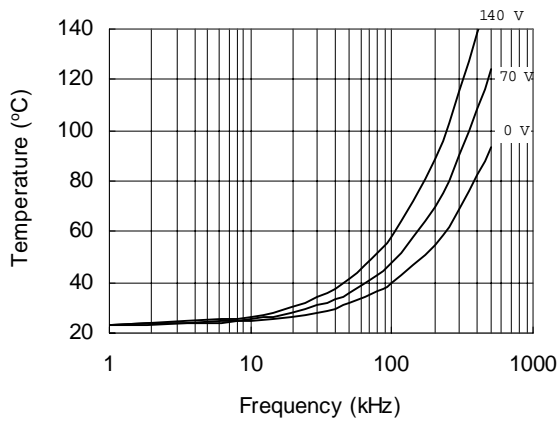

Figure 29. IRS21834 vs. Frequency (IRFPE50),
 $R_{gate}=10 \Omega, V_{CC}=15 V$

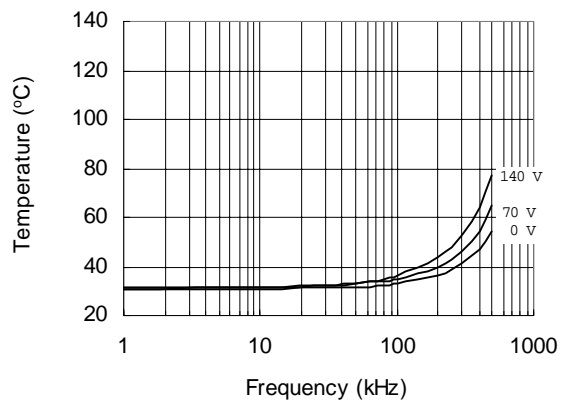
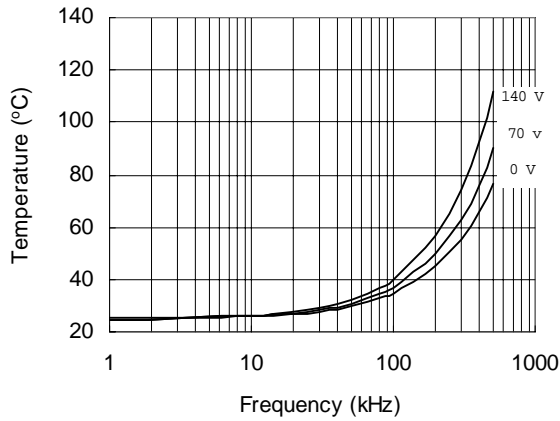
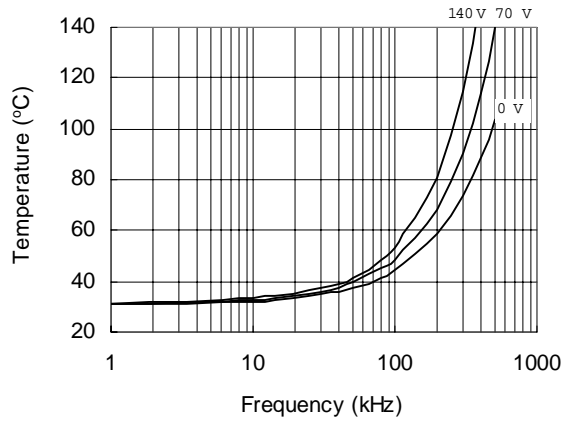

Figure 30. IRS2183S vs. Frequency (IRFBC20),
 $R_{gate}=33 \Omega, V_{CC}=15 V$

IRS2183/IRS21834(S)PbF



**Figure 31. IRS2183S vs. Frequency (IRFBC30),
 $R_{gate}=22 \Omega$, $V_{CC}=15 V$**



**Figure 32. IRS2183S vs. Frequency (IRFBC40),
 $R_{gate}=15 \Omega$, $V_{CC}=15 V$**

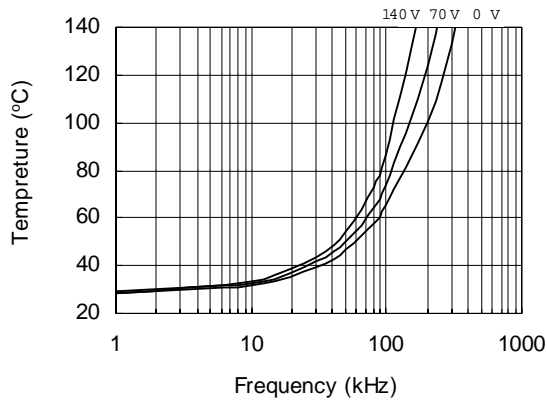

**Figure 33. IRS2183S vs. Frequency (IRFPE50),
 $R_{gate}=10 \Omega$, $V_{CC}=15 V$**

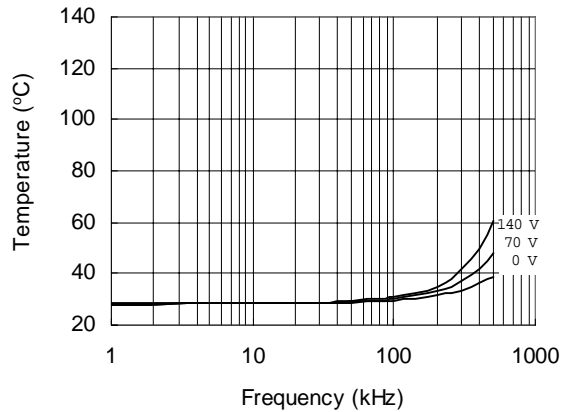

**Figure 34. IRS21834S vs. Frequency (IRFBC20),
 $R_{gate}=33 \Omega$, $V_{CC}=15 V$**

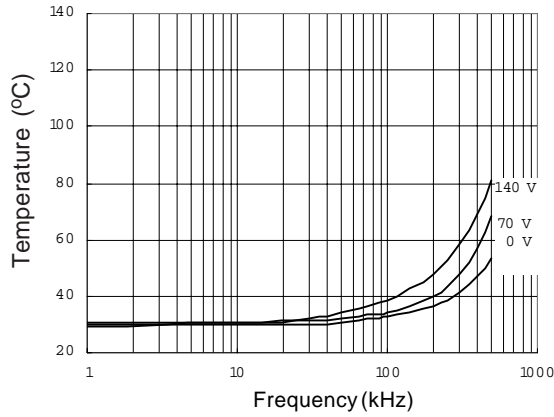

Figure 35. IRS21834S vs. Frequency (IRFBC30),
 $R_{gate}=22 \Omega, V_{CC}=15 V$

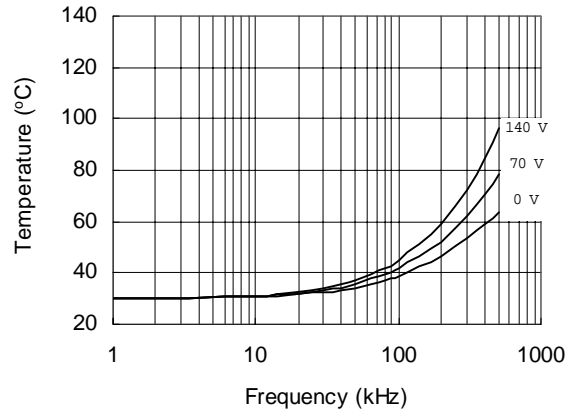

Figure 36. IRS21834S vs. Frequency (IRFBC40),
 $R_{gate}=15 \Omega, V_{CC}=15 V$

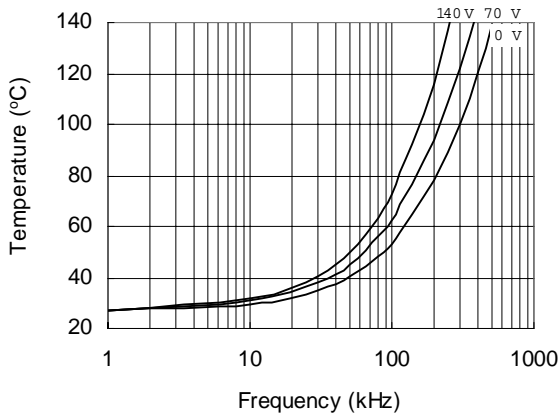
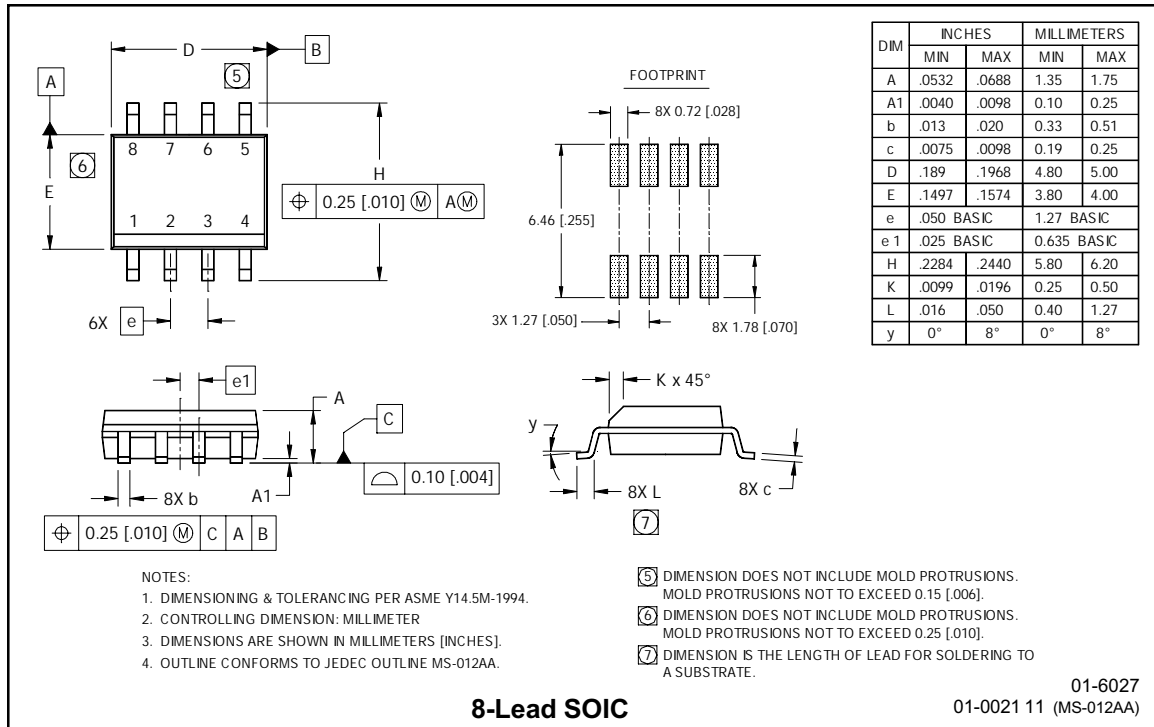
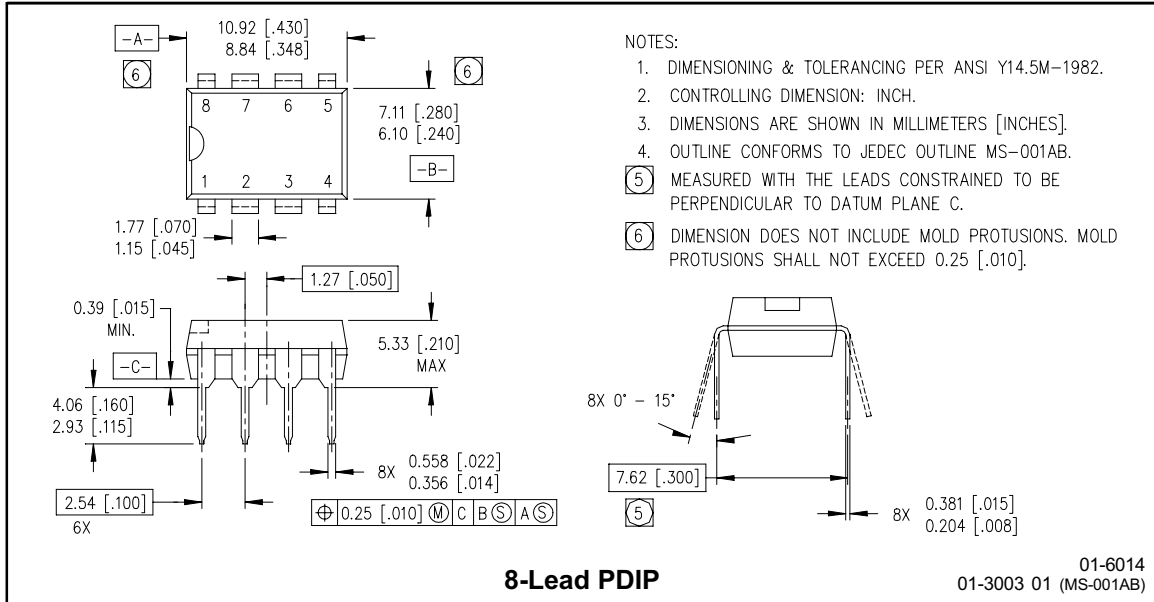
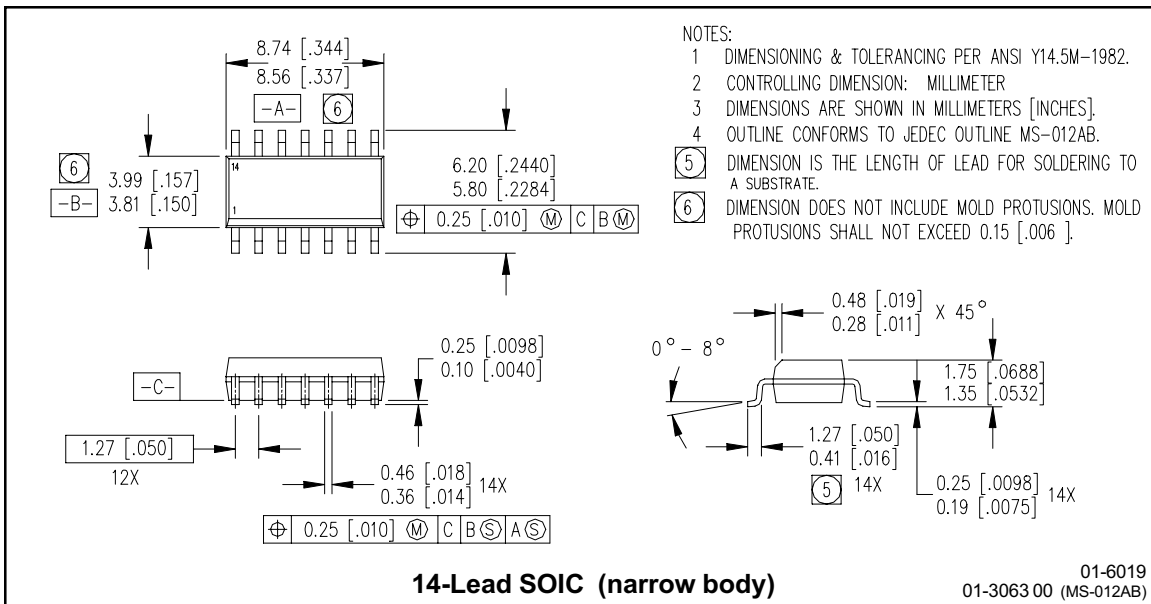
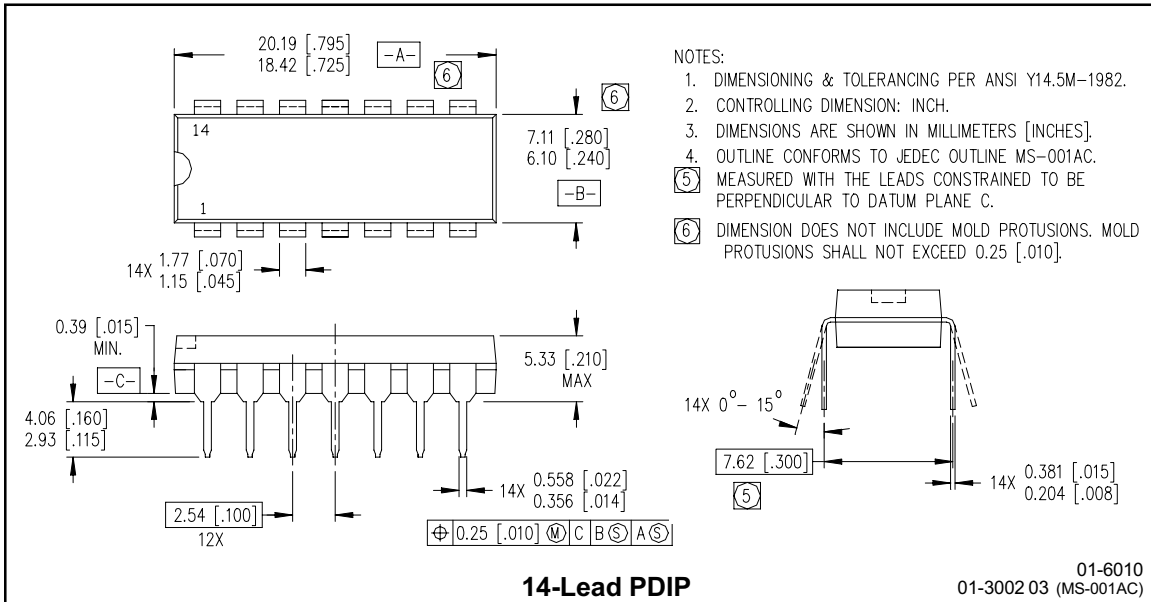

Figure 37. IRS21834S vs. Frequency (IRFPE50),
 $R_{gate}=10 \Omega, V_{CC}=15 V$

Case outlines



IRS2183/IRS21834(S)PbF



IRS2183/IRS21834(S)PbF

Tape & Reel 8-lead SOIC

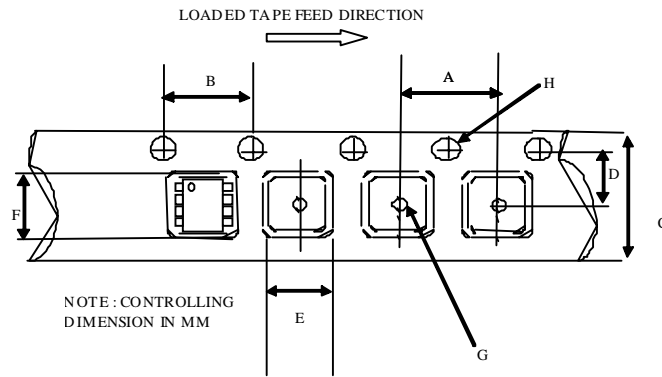

CARRIER TAPE DIMENSION FOR 8SOICN

Code	Metric		Imperial	
	Min	Max	Min	Max
A	7.90	8.10	0.311	0.318
B	3.90	4.10	0.153	0.161
C	11.70	12.30	0.46	0.484
D	5.45	5.55	0.214	0.218
E	6.30	6.50	0.248	0.255
F	5.10	5.30	0.200	0.208
G	1.50	n/a	0.059	n/a
H	1.50	1.60	0.059	0.062

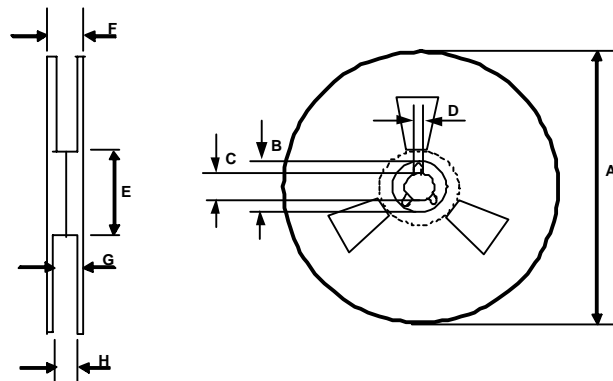

REEL DIMENSIONS FOR 8SOICN

Code	Metric		Imperial	
	Min	Max	Min	Max
A	329.60	330.25	12.976	13.001
B	20.95	21.45	0.824	0.844
C	12.80	13.20	0.503	0.519
D	1.95	2.45	0.767	0.096
E	98.00	102.00	3.858	4.015
F	n/a	18.40	n/a	0.724
G	14.50	17.10	0.570	0.673
H	12.40	14.40	0.488	0.566

Tape & Reel 14-lead SOIC

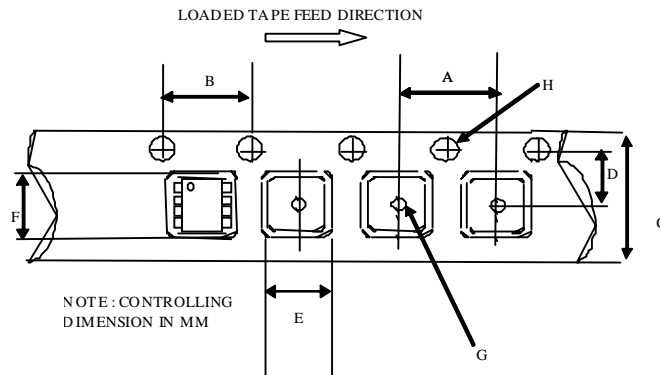

CARRIER TAPE DIMENSION FOR 14SOICN

Code	Metric		Imperial	
	Min	Max	Min	Max
A	7.90	8.10	0.311	0.318
B	3.90	4.10	0.153	0.161
C	15.70	16.30	0.618	0.641
D	7.40	7.60	0.291	0.299
E	6.40	6.60	0.252	0.260
F	9.40	9.60	0.370	0.378
G	1.50	n/a	0.059	n/a
H	1.50	1.60	0.059	0.062

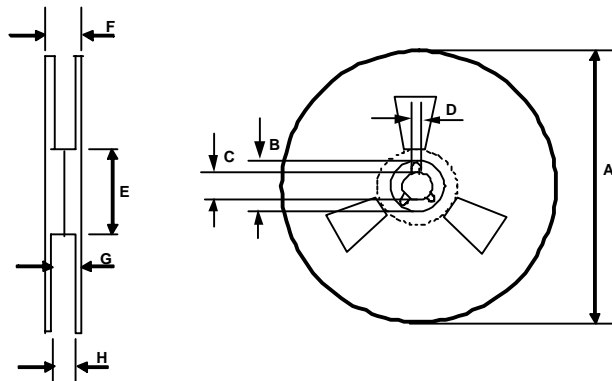

REEL DIMENSIONS FOR 14SOICN

Code	Metric		Imperial	
	Min	Max	Min	Max
A	329.60	330.25	12.976	13.001
B	20.95	21.45	0.824	0.844
C	12.80	13.20	0.503	0.519
D	1.95	2.45	0.767	0.096
E	98.00	102.00	3.858	4.015
F	n/a	22.40	n/a	0.881
G	18.50	21.10	0.728	0.830
H	16.40	18.40	0.645	0.724

LEADFREE PART MARKING INFORMATION

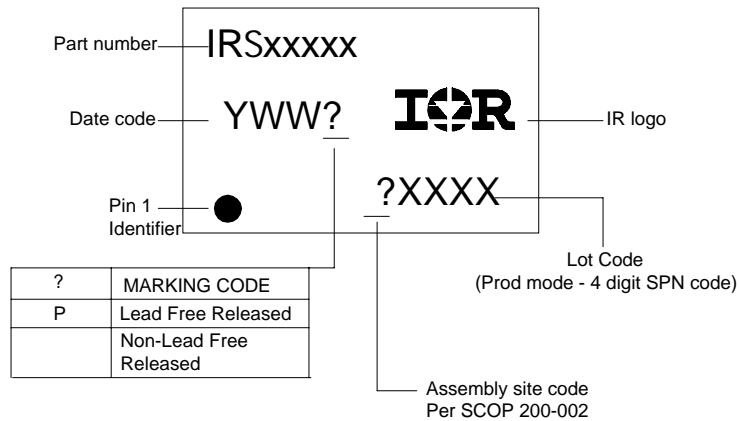

ORDER INFORMATION

8-Lead PDIP IRS2183PbF
 8-Lead SOIC IRS2183SPbF
 8-Lead SOIC Tape & Reel IRS2183STRPbF

14-Lead PDIP IRS21834PbF
 14-Lead SOIC IRS21834SPbF
 14-Lead SOIC Tape & Reel IRS21834STRPbF